

## FX850C

Runway Edge  
High intensity  
lighting solutions

### Compliant to Latest International Standards\*

- ▶ ICAO Annex 14. Vol 1
- ▶ FAA AC 150/5345-46
- ▶ FAA Engineering Brief No.67
- ▶ TP312
- ▶ MOS139
- ▶ IEC 61827
- ▶ EASA
- ▶ Stannag 3316 (NATO)

---

### Applications

CAT I/II/III all weather operation airfield ground lighting (agl) systems.

---

\* As applicable to the application, compliance with other civil aviation and military regulations confirmed on request

† Electrical/Mechanical/Environmental characteristics only

# FX850C LED Inset runway edge High intensity lighting solutions



## Electrical Performance

Main Beam Aperture		Colour	Typical Power Consumption - Watts (VA) @ 6.6A					
Horiz(°)	Vert(°)		Per Beam Watts nominal	Fitting*		Tx Primary**		
				Watts (VA)	PF	Watts (VA)	PF	
-2 to +9	0 to 7	WHT/WHT	39.7/39.7	119 (119.6)	0.99	154.8 (155.8)	0.99	
-2 to +9	0 to 7	WHT/YEL	39.7/16.2	88.3 (88.7)	0.99	123.9 (125.4)	0.98	
-2 to +9	0 to 7	WHT/RED	39.7/12.5	85.7 (86.0)	0.99	120.8 (122.7)	0.98	
-2 to +9	0 to 7	YEL/RED	16.2/12.5	55.0 (55.1)	0.99	89.9 (92.1)	0.98	

\* as measured at the input leads of the fixture.

\*\* as measured across the primary winding of an appropriately sized isolation transformer with a total fixture and transformer secondary length not exceeding - 1.85m (72").

\*\*\* electrical characteristics measured with 45 watt transformer, fitting can operate from transformers up to 210 watts.

Note: Isolating transformer shall be suitably sized to accommodate specific secondary and other applicable losses.

## Photometry

### Specification

#### Runway Edge ICAO Fig. A2-9 FAA L-850C

Colour	White
Max/Min Intensity ratio	<3.0
Main ellipse average intensity	1000cdfs
Main ellipse minimum intensity	5000cdfs
Second ellipse minimum intensity	1000cdfs
Third ellipse minimum intensity	500cdfs

#### Typical Measured Values

Colour	White
Max/Min Intensity ratio	2.43
Main ellipse average intensity	10166cdfs
Main ellipse maximum intensity	14349cdfs
Main ellipse minimum intensity	5910cdfs
Second ellipse minimum intensity	3432cdfs
Third ellipse minimum intensity	1793cdfs

### Specification

Colour	Yellow
Max/Min Intensity ratio	<3.0
Main ellipse average intensity	4000cdfs
Main ellipse minimum intensity	2000cdfs
Second ellipse minimum intensity	400cdfs
Third ellipse minimum intensity	200cdfs

#### Typical Measured Values

Colour	Yellow
Max/Min Intensity ratio	2.57
Main ellipse average intensity	5160cdfs
Main ellipse maximum intensity	7068cdfs
Main ellipse minimum intensity	2741cdfs
Second ellipse minimum intensity	1378cdfs
Third ellipse minimum intensity	880cdfs

### Specification

Colour	Red
Max/Min Intensity ratio	<3.0
Main ellipse average intensity	1500cdfs
Main ellipse minimum intensity	750cdfs
Second ellipse minimum intensity	150cdfs
Third ellipse minimum intensity	75cdfs

#### Typical Measured Values

Colour	Red
Max/Min Intensity ratio	2.27
Main ellipse average intensity	2122cdfs
Main ellipse maximum intensity	2918cdfs
Main ellipse minimum intensity	1285cdfs
Second ellipse minimum intensity	764cdfs
Third ellipse minimum intensity	465cdfs

Intensity Chart - Runway Edge Luminaire - White

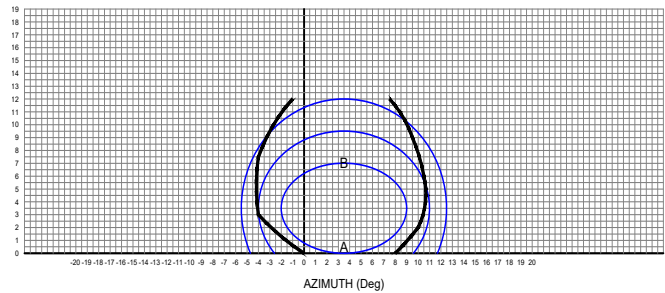

Intensity Chart - Runway Edge Luminaire - Yellow

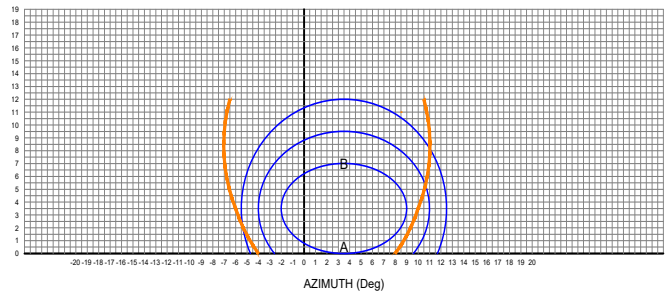

Intensity Chart - Runway Edge Luminaire - Red

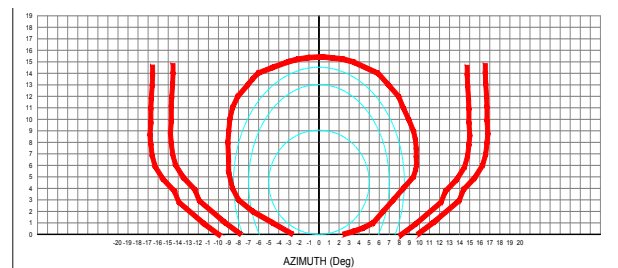

# FX850C LED Inset runway edge High intensity lighting solutions



## Features

- Low energy consumption compared with the tungsten halogen equivalent.
- Greatly reduced maintenance: calculated MTBF of 75,000 hours at 6.6A.
- Operates on the full range of 2.8A to 6.6A on either 3 or 5 step IGBT, ferroresonant or thyristor CCRs that are designed in compliance with IEC or FAA requirements.
- Fully dimmable lights, replicating the response curve of traditional halogen lights.
- Full compatibility with existing airfield lighting series circuits. Installation on same mounting device as most conventional lights, for a straightforward replacement.
- Monitoring function of the individual light arrays for open circuit, short circuit, and over temperature. The LED light automatically disconnects from the secondary side of the isolation transformer, resulting in an open circuit condition.
- Low operating temperature, ensuring longer component life.
- FAA style 3, ICAO style 4 fixture with a 6.0 mm profile above gradient
- L-823 connectors
- Integral surge protection

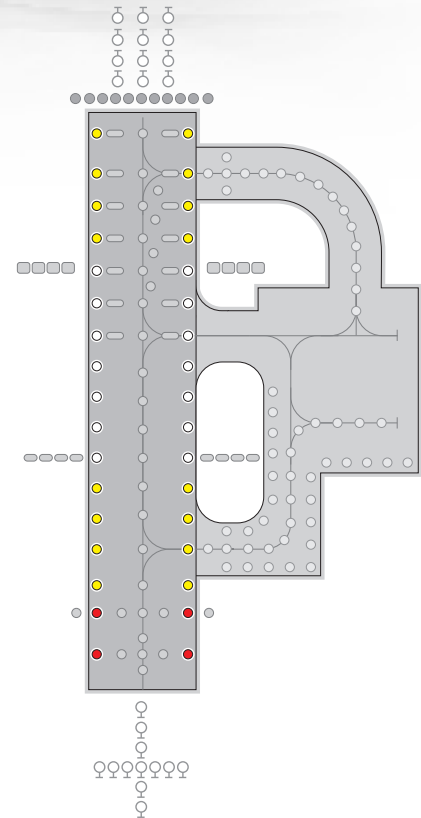

## Environmental Conditions

- ▶ Ambient Temperature -55 °C to +55°C (-67 °F to +131°F)
- ▶ Storage Temperature -55°C to +70°C (-67 °F to +158°F)
- ▶ Atmospheric Altitude up to 10,000 feet ( 3000m)
- ▶ Relative Humidity 0-100% (sealed unit)

Standards	
EMC protection	Immunity IEC 61000-4 Emission IEC 61000-2
Ingress protection class dust/liquids	IP68 (IEC69598-1)
Vibration resistance	IEC60068-2-6

UK: +44 (0) 1942 68 5555 | USA: +1 (239) 985-9406

www.atgairports.com | enquiries@atgairports.com | sales-usa@atgairports.com

L-850C(L)

# FX850C

LED Inset runway edge  
High intensity lighting solutions



Ordering Codes: **FX** **850C12** ○ ○ ○ ○ ○ **5** ○

**Application**  
L-850C (L) Runway Edge

**Beam Type**  
**A Side**  
3 = Toe in right †  
0 = Blank  
.....  
**B Side**  
2 = Toe in left †  
0 = Blank

**Colour**  
**A Side**  
W = White  
Y = Yellow  
R = Red  
N = Not applicable  
.....  
**B Side**  
W = White  
Y = Yellow  
R = Red  
N = Not applicable

**Omni Directional Component**  
7 = omni directional\*  
0 = Blank

**Specification**  
Refer to front cover

**Connections**  
1 = 1 x Bi-pin plug  
2 = 2 x Bi-pin plug

## Beam Options

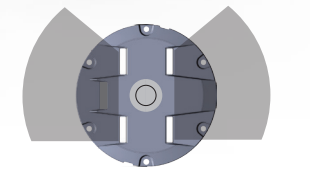

A  
B  
FX850C  
Bi-directional

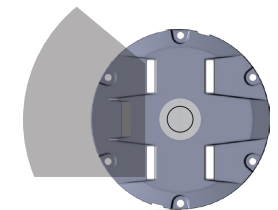

A  
FX850C  
Uni-directional

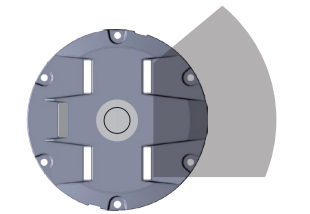

B  
FX850C  
Uni-directional

Optional omni directional element shown in all above options

Additional optional features may be available upon request

\* ICAO only

† This product has a 3.5° angle of toe and is suitable for runway width of 45Mts

UK: +44 (0) 1942 68 5555 | USA: +1 (239) 985-9406

L-850C(L)

www.atgairports.com enquiries@atgairports.com sales-usa@atgairports.com

# FX850C

LED Inset runway edge  
High intensity lighting solutions

## Dimensions

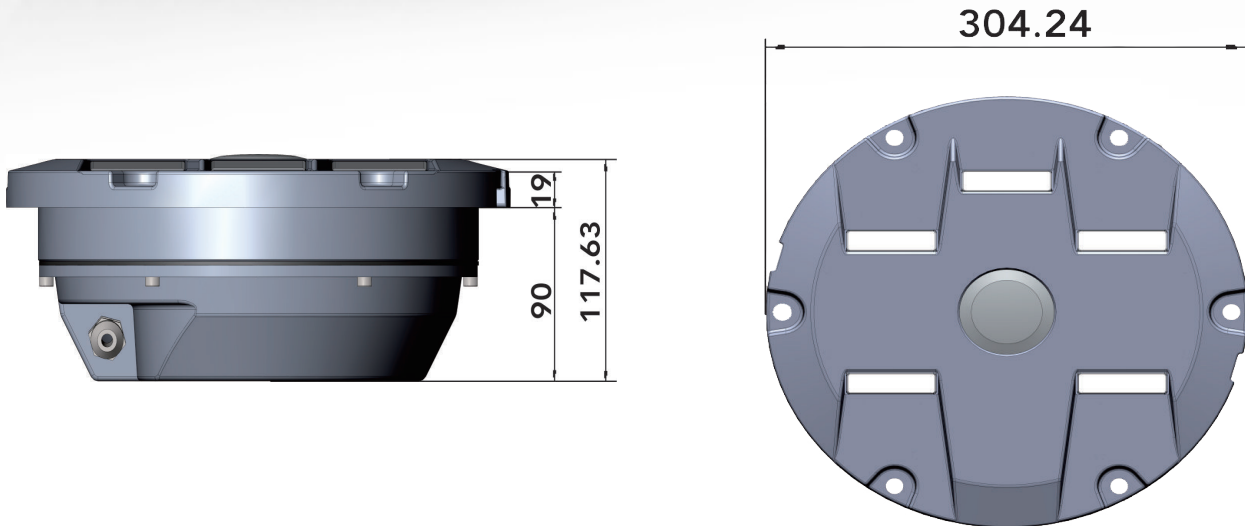

## Packaging

- ▶ Net weight 8.9Kg
- ▶ Gross weight 9.5 (boxed)
- ▶ Box 50mm (L) x 300mm (W) x 330mm (H)

weights and dimensions are nominal



**Head Office:**

**atg airports ltd**

Lowton Business Park | Newton Road

Lowton St. Mary's | Warrington

WA3 2AP | United Kingdom

atg airports reserve the right to change technical data and details at any point in time. Errors may have occurred



UK: +44 (0) 1942 68 5555 | USA: +1 (239) 985-9406

[www.atgairports.com](http://www.atgairports.com) [enquiries@atgairports.com](mailto:enquiries@atgairports.com) [sales-usa@atgairports.com](mailto:sales-usa@atgairports.com)

Rev 2 - 2020

L-850C(L)