

Tungsten halogen

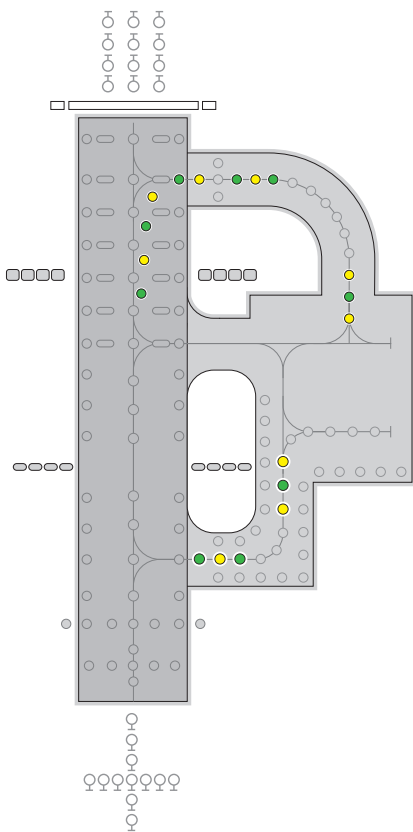

ZA280C

8" taxiway centre line, straight sections (narrow), high intensity lighting solutions



Applications

CAT I/II/III all weather operation airfield ground lighting (agl) systems

Compliant with Latest International Standards*

- ▶ ICAO Annex 14. Vol 1
- ▶ FAA AC 150/5345-46
- ▶ IEC 61827
- ▶ EASA
- ▶ Stannag 3316 (NATO)

* As applicable to the application, compliance with other civil aviation and military regulations confirmed on request

ZA280C 8" taxiway centre line, straight sections (narrow), high intensity lighting solutions



Electrical Performance

Main Beam Aperture		Colour	Power Consumption Watts (VA) @ 6.6A
Horiz(°)	Vert(°)		
-3.5 to +3.5	1 to 8	GRN/GRN	48W
-3.5 to +3.5	1 to 8	YEL/YEL	48W
-3.5 to +3.5	1 to 8	GRN/YEL	48W
-3.5 to +3.5	1 to 8	GRN/BLK	48W
-3.5 to +3.5	1 to 8	YEL/BLK	48W

Fixture Operational Current Range: 2.7 to 6.7A RMS

* as measured at the input leads of the fixture.

** as measured across the primary winding of an appropriately sized isolation transformer with a total fixture and transformer secondary length not exceeding - 1.85m (72").

Note: Isolating transformer shall be suitably sized to accommodate specific secondary and other applicable losses.

For Bi-directional twin lead option use unidirectional electrical performance for each direction.

Environmental Conditions

► Ambient Temperature -55 °C to +55°C (-67 °F to +131°F)

► Ingress Protection IP67

► Storage Temperature -55 °C to +55°C (-67 °F to +131°F)

Photometry

Specification

Taxiway Centreline - Straight Narrow ICAO Fig A2-13 FAA L-852C

Colour	Green
Max/Min Intensity Ratio	<3.0
Main rect. average intensity	200 cds
Main rect. minimum intensity	100 cds
Second rect. minimum intensity	20 cds

Typical Measured Values

Taxiway Centreline - Straight (Narrow) Green

Colour	Green
Max/Min Intensity Ratio	2.59
Main rect. average intensity	400 cds
Main rect. maximum intensity (A)	512 cds
Main rect. minimum intensity (B)	197 cds
Second rect. minimum intensity	120 cds

Specification

Taxiway Centreline - Straight (Narrow) Yellow

Colour	Yellow
Max/Min Intensity Ratio	<3.0
Main rect. average intensity	200 cds
Main rect. minimum intensity	100 cds
Second rect. minimum intensity	20 cds

Typical Measured Values

Taxiway Centreline - Straight (Narrow) Yellow

Colour	Yellow
Max/Min Intensity Ratio	1.96
Main rect. average intensity	462 cds
Main rect. maximum intensity (A)	584 cds
Main rect. minimum intensity (B)	299 cds
Second rect. minimum intensity	228 cds

Intensity Chart - Taxiway Centreline Luminaire (straight narrow) Green

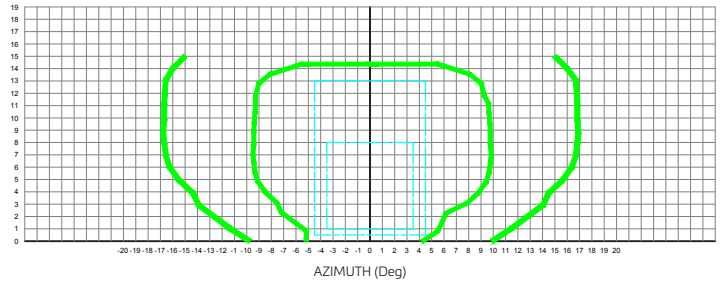

Intensity Chart - Taxiway Centreline Luminaire (straight narrow) Yellow

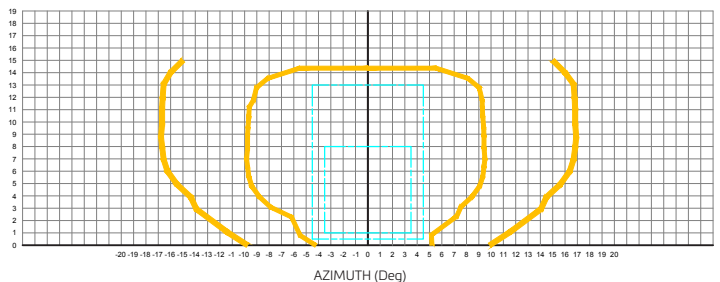

UK: +44 (0) 1942 68 5555 | USA: 001 (239) 985-9406

www.atgairports.com | products@atgairports.com | sales-usa@atgairports.com

L-852C

ZA280C 8" taxiway centre line, straight sections (narrow), high intensity lighting solutions



Ordering Codes ZA280 (TH) () () () () () ()

Application
L-852C Taxiway Centreline
Straight (Narrow)

Beam Type
A Side
4 = Straight (Narrow)
0 = Blank
.....
B Side
4 = Straight (Narrow)
0 = Blank

Colour
A Side
G = Green
Y = Yellow
N = Not Applicable
.....
B Side
G = Green
Y = Yellow
N = Not Applicable

Specification
1 = FAA
2 = ICAO

Connections
1 = 1 Bi Pin Plug
2 = 2 Bi Pin Plug

Beam Options

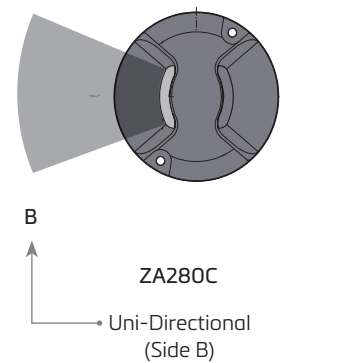
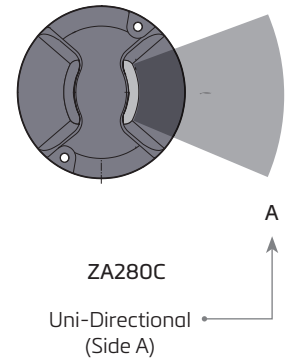
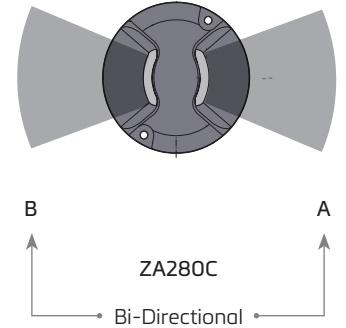

Additional optional features are available upon request

UK: +44 (0) 1942 68 5555 | USA: 001 (239) 985-9406

www.atgairports.com products@atgairports.com sales-usa@atgairports.com

L-852C

ZA280C 8" taxiway centre line, straight sections (narrow), high intensity lighting solutions

Dimensions

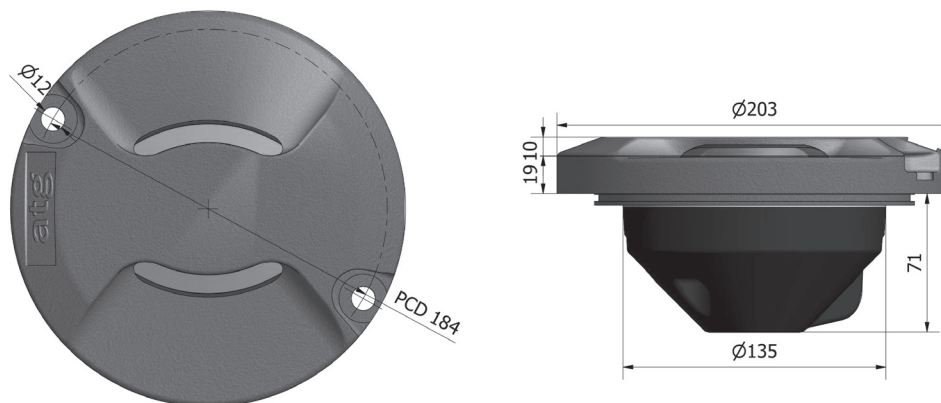

Packaging

- ▶ Net weight 3.0Kg
- ▶ Gross weight 3.51Kg (boxed)
- ▶ Box 230mm (L) x 230mm (W) x 146mm (H)

*Dimensions are nominal

Consultants specification and installation information for the Iris range is available by request. Contact enquiries@atgairports for further details.

atg airports reserve the right to change technical data and details at any point in time.



atg airports ltd
Lowton Business Park | Newton Road
Lowton St. Mary's | Warrington
WA3 2AP | United Kingdom

atg airports inc
7857 Drew Circle #13
Fort Myers | Florida 33967
USA



UK: +44 (0) 1942 68 5555 | USA: 001 (239) 985-9406

www.atgairports.com | products@atgairports.com | sales-usa@atgairports.com

L-852C